

Power Quality Application Guide



Harmonics

Causes and Effects

3.1

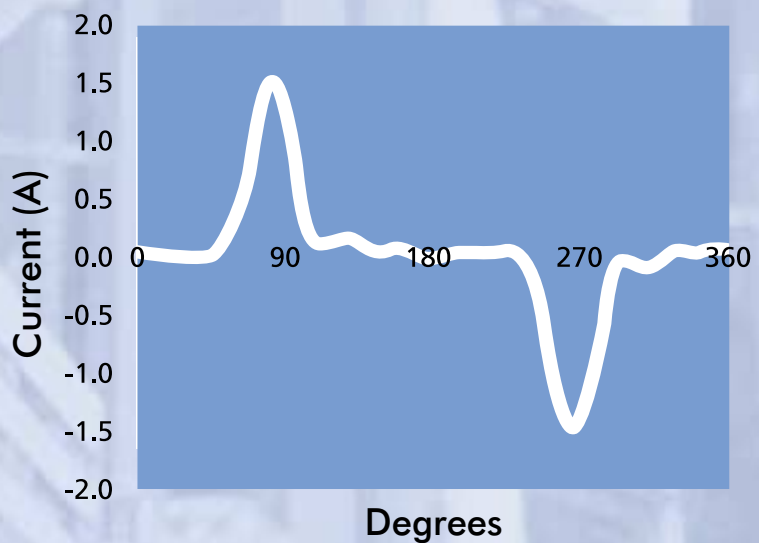
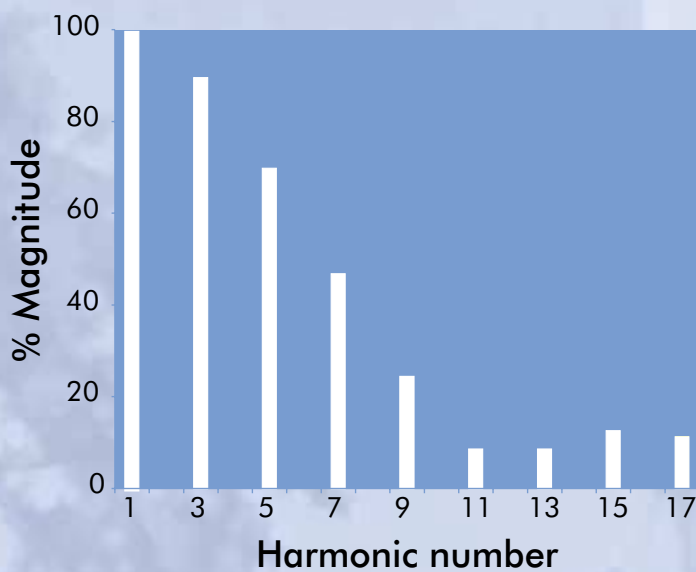

Harmonics

Causes and Effects

David Chapman
Copper Development Association
March 2001

(Version 0b November 2001)

European Copper Institute (ECI)

The European Copper Institute is a joint venture between ICA (International Copper Association) and IWCC (International Wrought Copper Council) contributing members. Through its membership, ECI acts on behalf of the world's largest copper producers and Europe's leading fabricators in promoting copper in Europe. Formed in January 1996, ECI is supported by a network of ten Copper Development Associations ('CDAs') in Benelux, France, Germany, Greece, Hungary, Italy, Poland, Scandinavia, Spain and the UK. It furthers the efforts initially undertaken by the Copper Products Development Association, formed in 1959, and INCRA (International Copper Research Association) formed in 1961.

Copper Development Association (CDA)

Copper Development Association is a non-trading organisation sponsored by the copper producers and fabricators to encourage the use of copper and copper alloys and to promote their correct and efficient application. Its services, which include the provision of technical advice and information, are available to those interested in the utilisation of copper in all its aspects. The Association also provides a link between research and the user industries and maintains close contact with the other copper development organisations throughout the world.

Acknowledgements

This project has been carried out with the support of the European Community and International Copper Association, Ltd.

Disclaimer

European Copper Institute and Copper Development Association disclaim liability for any direct, indirect, consequential or incidental damages that may result from the use of the information, or from the inability to use the information or data contained within this publication.

Copyright© European Copper Institute and Copper Development Association.

Reproduction is authorised providing the material is unabridged and the source is acknowledged.

Copper Development Association

Copper Development Association
Verulam Industrial Estate
224 London Road
St Albans AL1 1AQ
United Kingdom

Tel: 00 44 1727 731200
Fax: 00 44 1727 731216
Email: copperdev@compuserve.com
Websites: www.cda.org.uk and www.brass.org



European Copper Institute
168 Avenue de Tervueren
B-1150 Brussels
Belgium

Tel: 00 32 2 777 70 70
Fax: 00 32 2 777 70 79
Email: eci@eurocopper.org
Website: www.eurocopper.org

Harmonics

Causes and Effects

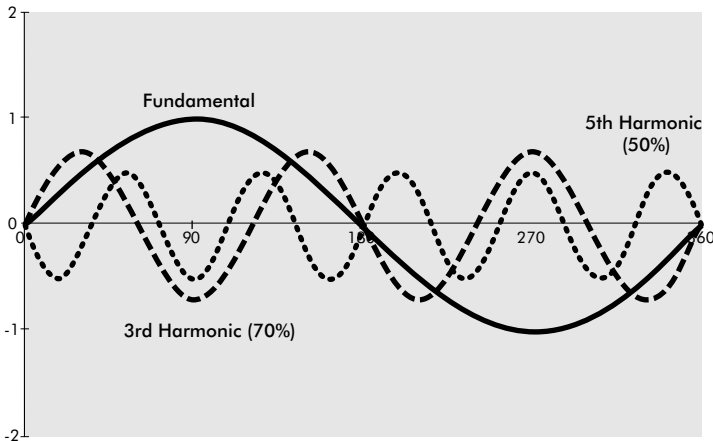

Figure 1 - Fundamental with third and fifth harmonics

Figure 2 shows a fundamental with 70 % third harmonic and 50 % fifth harmonic added. Note that in practice most distorted current waveforms will be much more complex than this example, containing many more harmonics with a more complex phase relationship.

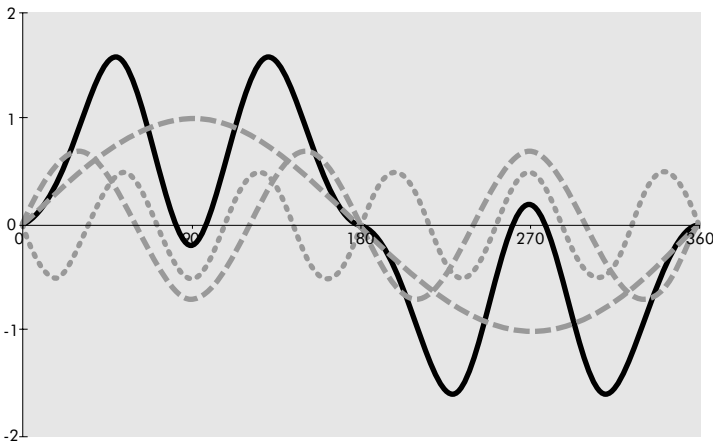

Figure 2 - Distorted current waveform

current harmonics but it is still common to find only the total harmonic distortion (THD) figures quoted. When harmonics propagate around a distribution system, that is, to branch circuits not concerned with carrying the harmonic current, they do so as voltages. It is very important that both voltage and current values are measured and that quoted values are explicitly specified as voltage and current values. Conventionally, current distortion measurements are suffixed with 'I', e.g. 35 % THDI, and voltage distortion figures with 'V', e.g. 4 % THDV.

Harmonic currents have been present in the electricity supply system for many years. Initially they were produced by the mercury arc rectifiers used to convert AC to DC current for railway electrification and for DC variable speed drives in industry. More recently the range of types and the number of units of equipment causing harmonics have risen sharply, and will continue to rise, so designers and specifiers must now consider harmonics and their side effects very carefully.

This section describes how and why harmonics are generated, how the presence of harmonics affects the electrical system and equipment and how to minimise these effects.

This section of the Guide covers the origin of harmonic currents and the effect that they have in electrical systems. Reduction methods are discussed in the 'Harmonic Solutions' sections.

Harmonic frequencies are integral multiples of the fundamental supply frequency, i.e. for a fundamental of 50 Hz, the third harmonic would be 150 Hz and the fifth harmonic would be 250 Hz. Figure 1 shows a fundamental sine wave with third and fifth harmonics.

This waveform is clearly not a sine wave and that means that normal measurement equipment, such as averaging reading rms-calibrated multi-meters, will give inaccurate readings. Note also that there are six zero crossing points per cycle instead of two, so any equipment that uses zero crossing as a reference will malfunction. The waveform contains non-fundamental frequencies and has to be treated accordingly.

When talking about harmonics in power installations it is the *current* harmonics that are of most concern because the harmonics originate as currents and most of the ill effects are due to these currents. No useful conclusions can be drawn without knowledge of the spectrum of the

Types of equipment that generate harmonics

Harmonic load currents are generated by all non-linear loads. These include:

Single phase loads, e.g.

- ◆ Switched mode power supplies (SMPS)
- ◆ Electronic fluorescent lighting ballasts
- ◆ Small uninterruptible power supplies (UPS) units

Three phase loads, e.g.

- ◆ Variable speed drives
- ◆ Large UPS units

Single phase loads

Switched mode power supplies (SMPS)

The majority of modern electronic units use switched mode power supplies (SMPS). These differ from older units in that the traditional step-down transformer and rectifier is replaced by direct controlled rectification of the supply to charge a reservoir capacitor from which the direct current for the load is derived by a method appropriate to the output voltage and current required. The advantage – to the equipment manufacturer – is that the size, cost and weight is significantly reduced and the power unit can be made in almost any

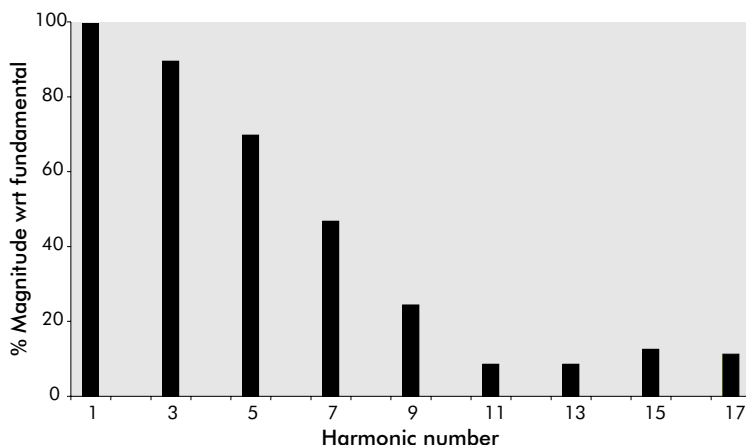

Figure 3 - Harmonic spectrum of a typical PC

required form factor. The disadvantage – to everyone else – is that, rather than drawing continuous current from the supply, the power supply unit draws pulses of current which contain large amounts of third and higher harmonics and significant high frequency components (see Figure 3). A simple filter is fitted at the supply input to bypass the high frequency components from line and neutral to ground but it has no effect on the harmonic currents that flow back to the supply. The earth leakage effects of these filters are discussed in Section 6.

Single phase UPS units exhibit very similar characteristics to SMPS.

For high power units there has been a recent trend towards so-called power factor corrected inputs. The aim is to make the power supply load look like a resistive load so that the input current appears sinusoidal and in phase with the applied voltage. It is achieved by drawing input current as a high frequency triangular waveform that is averaged by the input filter to a sinusoid. This extra level of sophistication is not yet readily applicable to the low-cost units that make up most of the load in commercial and industrial installations. It remains to be seen what problems the wide-scale application of this technology may involve!

Fluorescent lighting ballasts

Electronic lighting ballasts have become popular in recent years following claims for improved efficiency. Overall they are only a little more efficient than the best magnetic ballasts and in fact, most of the gain is attributable to the lamp being more efficient when driven at high frequency rather than to the electronic ballast itself. Their chief advantage is that the light level can be maintained over an extended lifetime by feedback control of the running current - a practice that reduces the overall lifetime efficiency. Their great disadvantage is that they generate harmonics in the supply current. So called power-factor corrected types

Causes and Effects

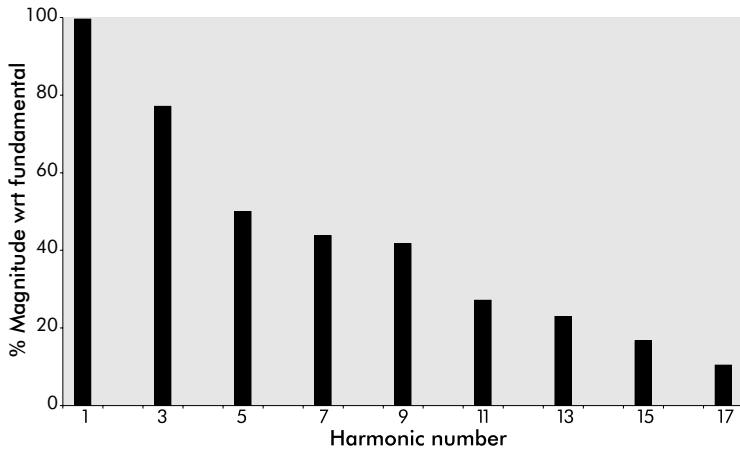

Figure 4 - Harmonic spectrum of a typical CFL

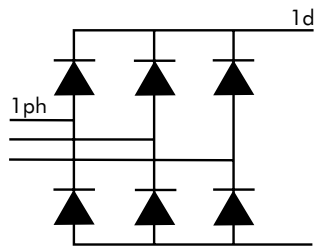

Figure 5 - Three-phase, or six-pulse, bridge

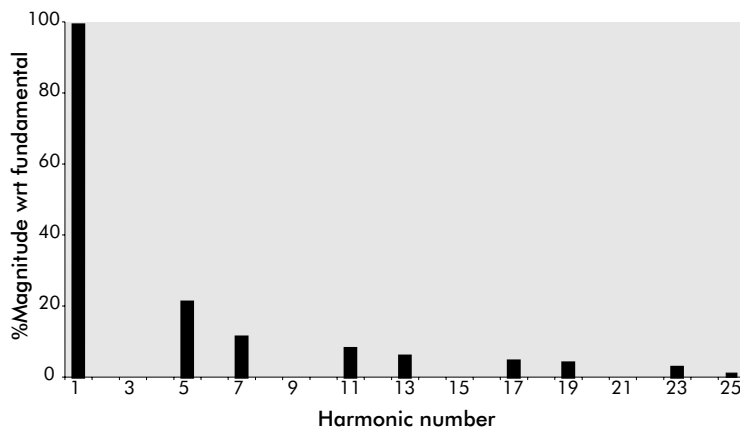

Figure 6 - Harmonic spectrum of a typical 6-pulse bridge

are available at higher ratings that reduce the harmonic problems, but at a cost penalty. Smaller units are usually uncorrected.

Compact fluorescent lamps (CFL) are now being sold as replacements for tungsten filament bulbs. A miniature electronic ballast, housed in the connector casing, controls a folded 8mm diameter fluorescent tube. CFLs rated at 11 watt are sold as replacements for a 60 watt filament lamp and have a life expectancy of 8000 hours. The harmonic current spectrum is shown in Figure 4. These lamps are being widely used to replace filament bulbs in domestic properties and especially in hotels where serious harmonic problems are suddenly becoming common.

Three phase loads

Variable speed controllers, UPS units and DC converters in general are usually based on the three-phase bridge, also known as the six-pulse bridge because there are six pulses per cycle (one per half cycle per phase) on the DC output.

The six pulse bridge produces harmonics at $6n \pm 1$, i.e. at one more and one less than each multiple of six. In theory, the magnitude of each harmonic is the reciprocal of the harmonic number, so there would be 20 % fifth harmonic and 9 % eleventh harmonic, etc.

A typical spectrum is shown in Figure 6.

The magnitude of the harmonics is significantly reduced by the use of a twelve-pulse bridge. This is effectively two six-pulse bridges, fed from a star and a delta transformer winding, providing a 30 degrees phase shift between them.

The $6n$ harmonics are theoretically removed, but in practice, the amount of reduction depends on the matching of the converters and is typically by a factor between 20 and 50. The $12n$ harmonics remain unchanged. Not only is the total harmonic current reduced, but also those that remain are of a higher order making the design of the filter much easier.

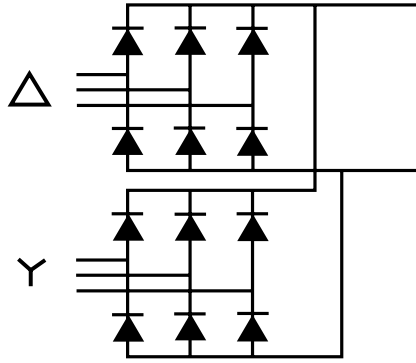

Figure 7 - Twelve-pulse bridge

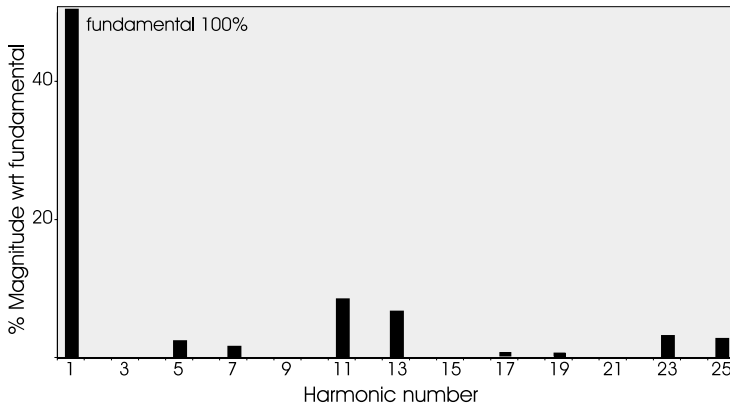

Figure 8 - Harmonic spectrum of a typical 12 pulse bridge

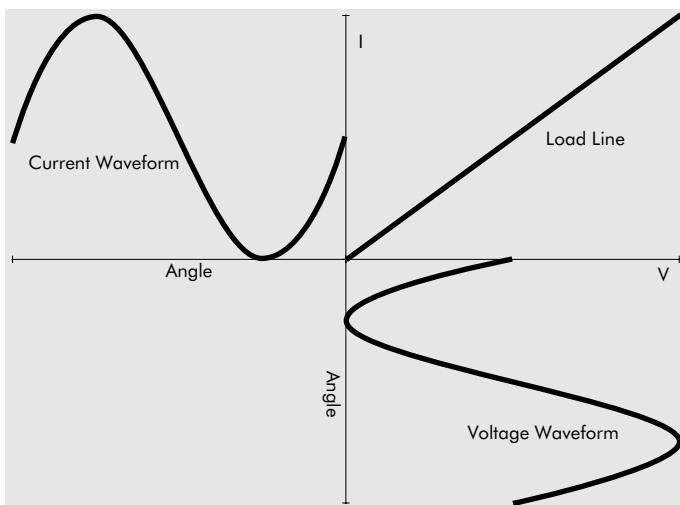

Figure 9 - Current waveform in a linear load

Often the equipment manufacturer will have taken some steps to reduce the magnitudes of the harmonic currents, perhaps by the addition of a filter or series inductors. In the past this has led some manufacturers to claim that their equipment is 'G5/3' compliant. Since G5/3 is a planning standard applicable to a complete installation, it cannot be said to have been met without knowledge of every piece of equipment on the site.

A further increase in the number of pulses to 24, achieved by using two parallel twelve-pulse units with a phase shift of 15 degrees, reduces the total harmonic current to about 4.5 %. The extra sophistication increases cost, of course, so this type of controller would be used only when absolutely necessary to comply with the electricity suppliers' limits.

Theoretical background – how harmonics are generated

In an ideal clean power system, the current and voltage waveforms are pure sinusoids. In practice, non-sinusoidal *currents* result when the current flowing in the load is not linearly related to the applied voltage. In a simple circuit containing only linear circuit elements - resistance, inductance and capacitance - the current which flows is proportional to the applied voltage (at a particular frequency) so that, if a sinusoidal voltage is applied, a sinusoidal current will flow, as illustrated in Figure 9. The load-line is the relationship between the voltage applied and the current that results in the load; that shown in Figure 9 corresponds to a linear load. Note that where there is a reactive element there will be a phase shift between the voltage and current waveforms; the power factor is reduced, but the circuit can still be linear.

Figure 10 shows the situation where the load is a simple full-wave rectifier and capacitor, such as the input stage of a typical switched mode power supply. In this case, current flows only when the supply voltage exceeds that stored on the reservoir capacitor, i.e. close to the peak of

Causes and Effects

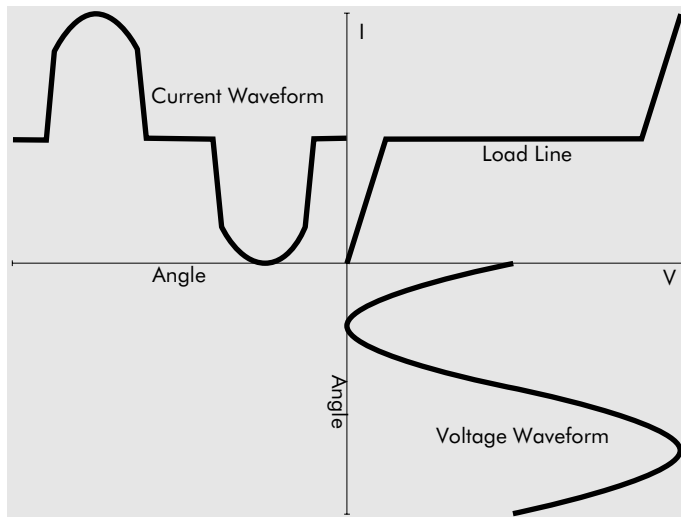

Figure 10 - Current waveform in a non-linear load

the voltage sinewave, as shown by the shape of the load line.

In practice, the load line (and hence the current waveform) is likely to be much more complex than shown in this illustrative example; there may be some asymmetry and hysteresis and the breakpoints and slopes will change with loading.

Any cyclical waveform can be deconstructed into a sinusoid at the fundamental frequency plus a number of sinusoids at harmonic frequencies. Thus the distorted current waveform in Figure 10 can be represented by the fundamental plus a percentage of second harmonic plus a percentage of third harmonic and so on, possibly up to the thirtieth harmonic. For symmetrical waveforms, i.e. where the positive and negative half cycles are the same shape and magnitude, all the even numbered harmonics are zero. Even harmonics are now relatively rare but were common when half wave rectification was widely used.

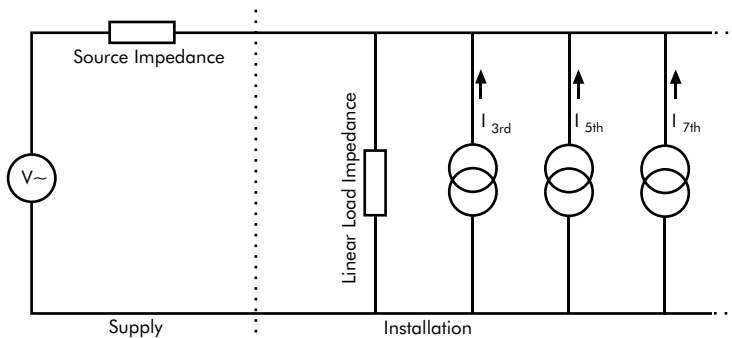

Figure 11 - Equivalent circuit of a non-linear load

The equivalent circuit of a non-linear load is shown in Figure 11. It can be modelled as a linear load in parallel with a number of current sources, one source for each harmonic frequency.

The harmonic currents generated by the load – or more accurately converted by the load from fundamental to harmonic current – have to flow around the circuit via the source impedance and all other parallel paths. As a result, harmonic voltages appear across the supply

impedance and are present throughout the installation. Harmonic generators are sometimes shown as voltage generators; if this were true then the source impedance would have no influence on the magnitude of the harmonic voltage across the source. In reality the magnitude of this voltage is proportional (over a limited range) to the source impedance indicating that the generator behaves as a current source.

Source impedances are very low so the harmonic voltage distortion resulting from a harmonic current is also low and often hardly above the network background. This can be misleading because it gives the impression that there is not likely to be a harmonic problem when in fact large harmonic currents are present. It is rather similar to trying to find a circulating earth current with a voltmeter. Whenever harmonics are suspected, or when trying to verify their absence, the current must be measured.

Problems caused by harmonics

Harmonic currents cause problems both on the supply system and within the installation. The effects and the solutions are very different and need to be addressed separately; the measures that are appropriate to controlling the effects of harmonics within the installation may not necessarily reduce the distortion caused on the supply and vice versa.

Harmonic problems within the installation

There are several common problem areas caused by harmonics: -

- ◆ Problems caused by harmonic currents:
 - ◆ overloading of neutrals
 - ◆ overheating of transformers
 - ◆ nuisance tripping of circuit breakers
 - ◆ over-stressing of power factor correction capacitors
 - ◆ skin effect
- ◆ Problems caused by harmonic voltages:
 - ◆ voltage distortion
 - ◆ induction motors
 - ◆ zero-crossing noise
- ◆ Problems caused when harmonic currents reach the supply

Each of these areas is discussed briefly in the following sections.

Problems caused by harmonic currents

Neutral conductor over-heating

In a three-phase system the voltage waveform from each phase to the neutral star point is displaced by 120° so that, when each phase is equally loaded, the combined current in the neutral is zero. When the loads are not balanced only the net out of balance current flows in the neutral. In the past, installers (with the approval of the standards authorities) have taken advantage of this fact by installing *half-sized* neutral conductors. However, although the fundamental currents cancel out, the harmonic currents do not - in fact those that are an odd multiple of three times the fundamental, the 'triple-N' harmonics, add in the neutral. Figure 12 shows the effect. In this diagram the phase currents, shown at the top, are introduced at 120°

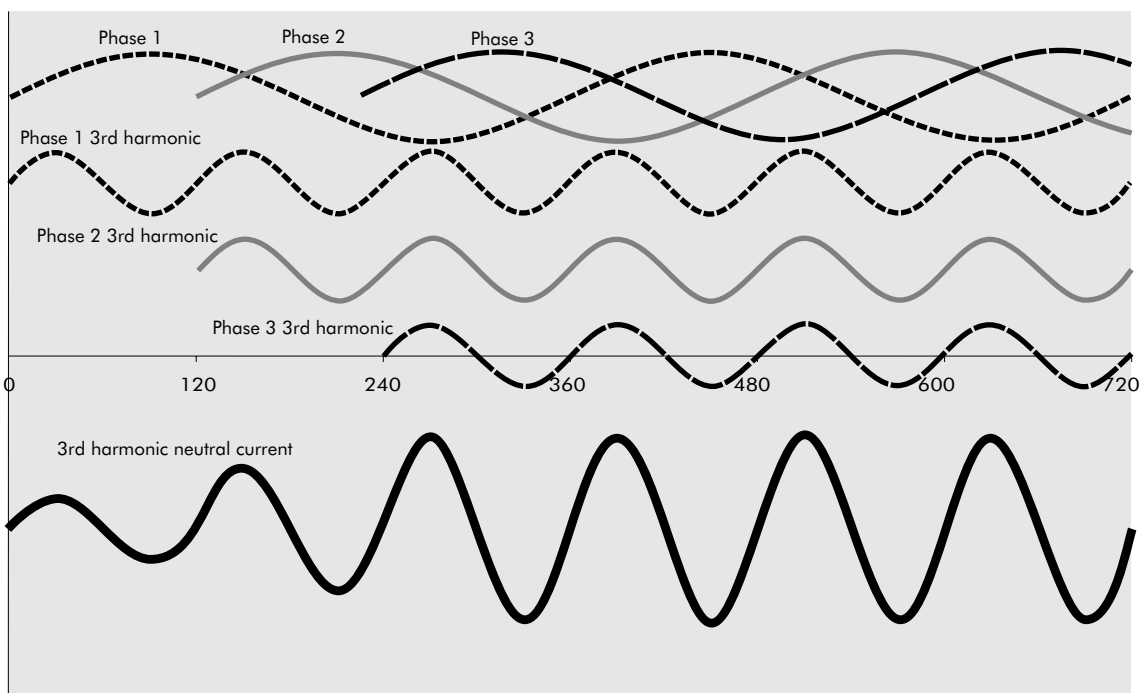

Figure 12 – Triple-N currents add in the neutral

Causes and Effects

intervals. The third harmonic of each phase is identical, being three times the frequency and one-third of a (fundamental) cycle offset. The effective third harmonic neutral current is shown at the bottom. In this case, 70 % third harmonic current in each phase results in 210 % current in the neutral.

Case studies in commercial buildings generally show neutral currents between 150 % and 210 % of the phase currents, often in a *half-sized* conductor!

There is some confusion as to how designers should deal with this issue. The simple solution, where single-cored cables are used, is to install a double sized neutral, either as two separate conductors or as one single large conductor. The situation where multi-cored cables are used is not so simple. The ratings of multi-core cables (for example as given in IEC 60364-5-523 Table 52 and BS 7671 Appendix 4) assume that the load is balanced and the neutral conductor carries no current, in other words, only three of the four or five cores carry current and generate heat. Since the cable current carrying capacity is determined solely by the amount of heat that it can dissipate at the maximum permitted temperature, it follows that cables carrying

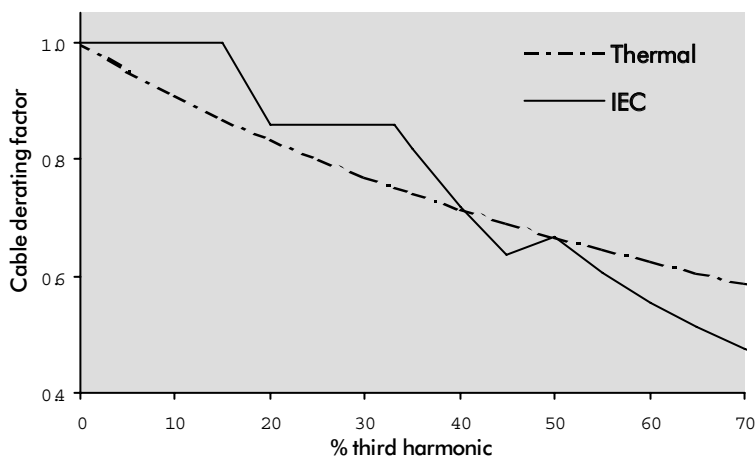

Figure 13 - Cable derating for triple-N harmonics

triple-N currents must be de-rated. In the example illustrated above, the cable is carrying five units of current – three in the phases and two in the neutral – while it was rated for three units. It should be de-rated to about 60 % of the normal rating.

IEC 60364-5-523 Annex C (Informative) suggests a range of de-rating factors according to the triple-N harmonic current present. Figure 13 shows derating factor against triple-N harmonic content for the de-rating described in IEC 60364-5-523 Annex C and for the thermal method used above.

The regulatory position is under discussion at present and it is likely that new requirements and guidance notes will be introduced into national wiring codes in the near future.

Effects on transformers

Transformers are affected in two ways by harmonics. Firstly, the eddy current losses, normally about 10 % of the loss at full load, increase with the square of the harmonic number. In practice, for a fully loaded transformer supplying a load comprising IT equipment the total transformer losses would be twice as high as for an equivalent linear load. This results in a much higher operating temperature and a shorter life. In fact, under these circumstances the lifetime would reduce from around 40 years to more like 40 days! Fortunately, few transformers are fully loaded, but the effect must be taken into account when selecting plant.

The second effect concerns the triple-N harmonics. When reflected back to a delta winding they are all in phase, so the triple-N harmonic currents circulate in the winding. The triple-N harmonics are effectively absorbed in the winding and do not propagate onto the supply, so delta wound transformers are useful as isolating transformers. Note that all other, non triple-N, harmonics pass through. The circulating current has to be taken into account when rating the transformer.

A detailed discussion on rating transformers for harmonic currents can be found in a later section of the Guide.

Nuisance tripping of circuit breakers

Residual current circuit breakers (RCCB) operate by summing the current in the phase and neutral conductors and, if the result is not within the rated limit, disconnecting the power from the load. Nuisance tripping can occur in the presence of harmonics for two reasons. Firstly, the RCCB, being an electromechanical device, may not sum the higher frequency components correctly and therefore trips erroneously. Secondly, the kind of equipment that generates harmonics also generates switching noise that must be filtered at the equipment power connection. The filters normally used for this purpose have a capacitor from line and neutral to ground, and so leak a small current to earth. This current is limited by standards to less than 3.5 mA, and is

Causes and Effects

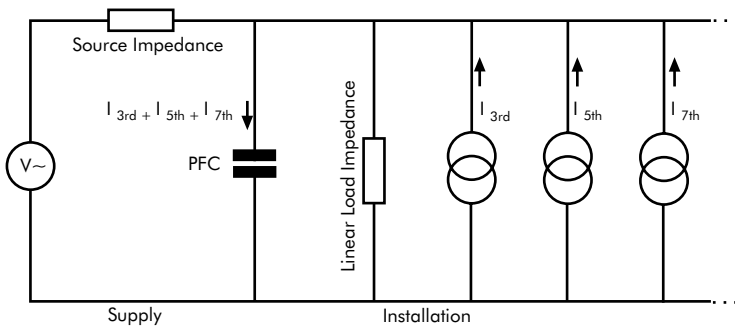

Figure 14 - Equivalent circuit of a non-linear load with a PFC capacitor

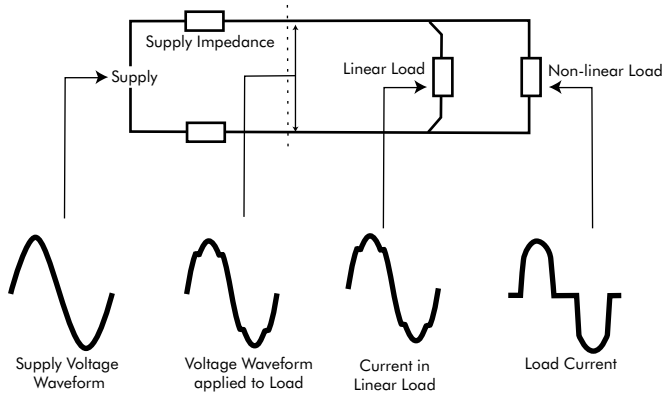

Figure 15 - Voltage distortion caused by a non-linear load

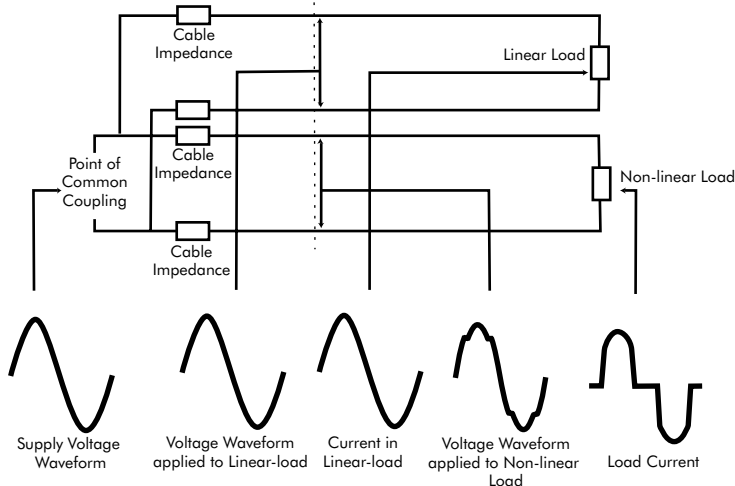

Figure 16 - Separation of linear and non-linear loads

usually much lower, but when equipment is connected to one circuit the leakage current can be sufficient to trip the RCCB. The situation is easily overcome by providing more circuits, each supplying fewer loads. A later section of this Guide covers the problem of high earth leakage in greater detail.

Nuisance tripping of miniature circuit breakers (MCB) is usually caused because the current flowing in the circuit is higher than that expected from calculation or simple measurement due to the presence of harmonic currents. Most portable measuring instruments do not measure true RMS values and can underestimate non-sinusoidal currents by 40 %. True RMS measurement is discussed in Section 3.2.2.

Over-stressing of power factor correction capacitors

Power factor correction capacitors are provided in order to draw a current with a leading phase angle to offset lagging current drawn by an inductive load such as induction motors. Figure 14 shows the effective equivalent circuit for a PFC capacitor with a non-linear load. The impedance of the PFC capacitor reduces as frequency rises, while the source impedance is generally inductive and increases with frequency. The capacitor is therefore likely to carry quite high harmonic currents and, unless it has been specifically designed to handle them, damage can result.

A potentially more serious problem is that the capacitor and the stray inductance of the supply system can resonate at or near one of the harmonic frequencies (which, of course, occur at 100 Hz intervals). When this happens very large voltages and currents can be generated, often leading to the catastrophic failure of the capacitor system.

Resonance can be avoided by adding an inductance in series with the capacitor such that the combination is just inductive at the lowest significant harmonic. This solution also limits the harmonic current that can flow in the capacitor. The physical size of the inductor can be a problem, especially when low order harmonics are present.

Causes and Effects

Skin effect

Alternating current tends to flow on the outer surface of a conductor. This is known as skin effect and is more pronounced at high frequencies. Skin effect is normally ignored because it has very little effect at power supply frequencies but above about 350 Hz, i.e. the seventh harmonic and above, skin effect will become significant, causing additional loss and heating. Where harmonic currents are present, designers should take skin effect into account and de-rate cables accordingly. Multiple cable cores or laminated busbars can be used to help overcome this problem. Note also that the mounting systems of busbars must be designed to avoid mechanical resonance at harmonic frequencies. Design guidance on both these issues is given in CDA Publication 22, 'Copper for Busbars'.

Problems caused by harmonic voltages

Because the supply has source impedance, harmonic load currents give rise to harmonic voltage distortion on the voltage waveform (this is the origin of 'flat topping'). There are two elements to the impedance: that of the internal cabling from the point of common coupling (PCC), and that inherent in the supply at the PCC, e.g. the local supply transformer. The former is illustrated in Figure 15.

The distorted load current drawn by the non-linear load causes a distorted voltage drop in the cable impedance. The resultant distorted voltage waveform is applied to all other loads connected to the same circuit, causing harmonic currents to flow in them - even if they are linear loads.

The solution is to separate circuits supplying harmonic generating loads from those supplying loads which are sensitive to harmonics, as shown in Figure 16. Here separate circuits feed the linear and non-linear loads from the point of common coupling, so that the voltage distortion caused by the non-linear load does not affect the linear load.

When considering the magnitude of harmonic voltage distortion it should be remembered that, when the load is transferred to a UPS or standby generator during a power failure, the source impedance and the resulting voltage distortion will be much higher.

Where local transformers are installed, they should be selected to have sufficiently low output impedance and to have sufficient capacity to withstand the additional heating, in other words, by selecting an appropriately oversized transformer. Note that it is not appropriate to select a transformer design in which the increase in capacity is achieved simply by forced cooling – such a unit will run at higher internal temperatures and have a reduced service life. Forced cooling should be reserved for emergency use only and never relied upon for normal running.

Induction Motors

Harmonic voltage distortion causes increased eddy current losses in motors in the same way as in transformers. However, additional losses arise due to the generation of harmonic fields in the stator, each of which is trying to rotate the motor at a different speed either forwards or backwards. High frequency currents induced in the rotor further increase losses.

Where harmonic voltage distortion is present motors should be de-rated to take account of the additional losses.

Zero-crossing noise

Many electronic controllers detect the point at which the supply voltage crosses zero volts to determine when loads should be turned on. This is done because switching reactive loads at zero voltage does not generate transients, so reducing electromagnetic interference (EMI) and stress on the semiconductor switching devices. When harmonics or transients are present on the supply the rate of change of voltage at the crossing becomes faster and more difficult to identify, leading to erratic operation. There may in fact be several zero-crossings per half cycle.

Harmonic problems affecting the supply

When a harmonic current is drawn from the supply it gives rise to a harmonic voltage drop proportional to the source impedance at the point of common coupling (PCC) and the current. Since the supply network is generally inductive, the source impedance is higher at higher frequencies. Of course, the voltage at the PCC is already distorted by the harmonic currents drawn by other consumers and by the distortion inherent in transformers, and each consumer makes an additional contribution.

Causes and Effects

Clearly, customers cannot be allowed to add pollution to the system to the detriment of other users, so in most countries the electrical supply industry has established regulations limiting the magnitude of harmonic current that can be drawn. Many of these codes are based on the UK Electricity Association's G5/3 issued in 1975, recently replaced by G5/4 (2001). This standard is discussed in detail elsewhere in this Guide.

Harmonic mitigation measures

The measures available to control the magnitude of harmonic current drawn are discussed in detail in later sections of this Guide. In this section a brief overview is given in generic terms. Mitigation methods fall broadly into three groups; passive filters, isolation and harmonic reduction transformers and active solutions. Each approach has advantages and disadvantages, so there is no single best solution. It is very easy to spend a great deal of money on an inappropriate and ineffective solution; the moral is to carry out a thorough survey – tools suitable for this purpose are described elsewhere in this Guide.

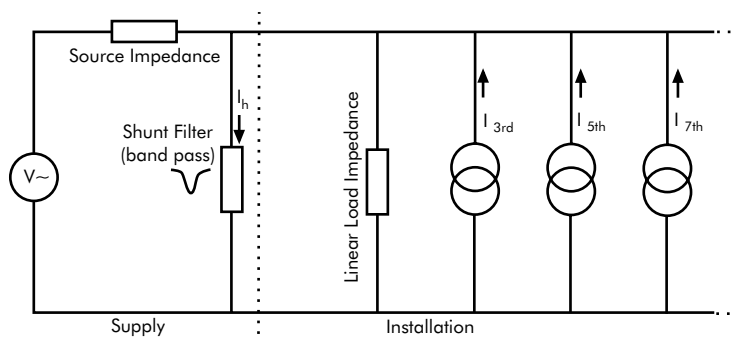

Figure 17 - Passive harmonic shunt filter

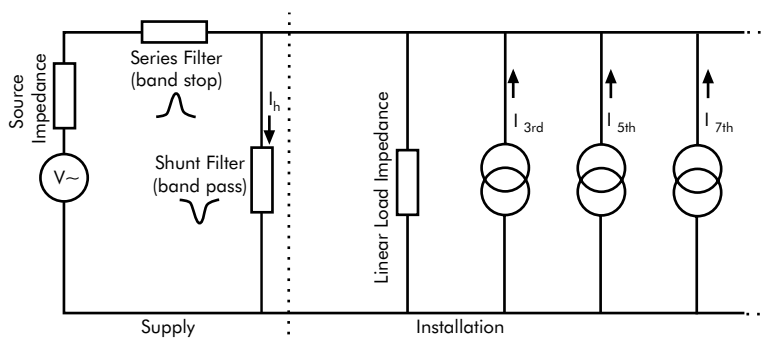

Figure 18 - Passive series and shunt filters

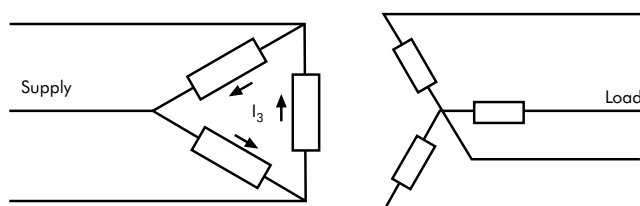

Figure 19 - Delta star isolation transformer

Passive filters

Passive filters are used to provide a low impedance path for harmonic currents so that they flow in the filter and not the supply (Figure 17). The filter may be designed for a single harmonic or for a broad band depending on requirements.

Sometimes it is necessary to design a more complex filter to increase the series impedance at harmonic frequencies and so reduce the proportion of current that flows back onto the supply, as shown in Figure 18.

Simple series band stop filters are sometimes proposed, either in the phase or in the neutral. A series filter is intended to block harmonic currents rather than provide a controlled path for them so there is a large harmonic voltage drop across it. This harmonic voltage appears across the supply on the load side. Since the supply voltage is heavily distorted it is no longer within the standards for which equipment was designed and warranted. Some equipment is relatively insensitive to this distortion, but some is very sensitive. Series filters can be useful in certain circumstances, but should be carefully applied; they cannot be recommended as a general purpose solution.

Isolation transformers

As mentioned previously, triple-N currents circulate in the delta windings of transformers. Although this is a problem for transformer manufacturers and specifiers - the extra load has to be taken into account – it is beneficial to systems designers because it isolates triple-N harmonics from the supply.

Causes and Effects

The same effect can be obtained by using a 'zig-zag' wound transformer. Zig-zag transformers are star configuration auto transformers with a particular phase relationship between the windings that are connected in shunt with the supply.

Active Filters

The solutions mentioned so far have been suited only to particular harmonics, the isolating transformer being useful only for triple-N harmonics and passive filters only for their designed harmonic frequency. In some installations the harmonic content is less predictable. In many IT installations, for example, the equipment mix and location is constantly changing so that the harmonic culture is also constantly changing. A convenient solution is the active filter or active conditioner.

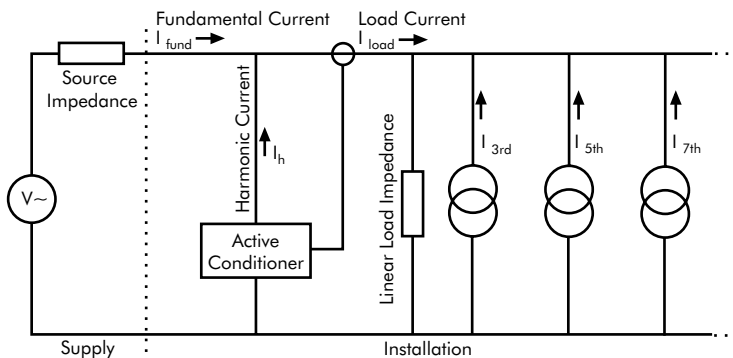

Figure 20 - Active harmonic conditioner

As shown in Figure 20, the active filter is a shunt device. A current transformer measures the harmonic content of the load current, and controls a current generator to produce an exact replica that is fed back onto the supply on the next cycle. Since the harmonic current is sourced from the active conditioner, only fundamental current is drawn from the supply. In practice, harmonic current magnitudes are reduced by 90 % and, because the source impedance at harmonic frequencies is reduced, voltage distortion is reduced.

Conclusion

Virtually all modern electrical and electronic equipment contains a SMPS or involves some form of power control and so is a non-linear load. Linear loads are comparatively rare, undimmed filament bulbs and uncontrolled heaters being the only common examples.

Future equipment Standards are discussed in detail in a later section of this Guide, but have not been set tightly enough to make a real impact on harmonic pollution produced by electronic equipment such as PCs. It is this class of equipment that is causing many of the harmonic problems seen in industry and commerce today, partly because there are so many of them installed and partly because the type of harmonics they produce – the triple-Ns – cause so many problems.

As the quantity of installed equipment rises, and without very strong standards backed up by rigid enforcement measures, it is likely that harmonic pollution will continue to increase. This is a risk to business that needs to be managed by investment in good design practice, the right electrical equipment and good maintenance.

Network Partners

Copper Benelux

168 Avenue de Tervueren
B-1150 Brussels
Belgium

Tel: 00 32 2 777 7090
Fax: 00 32 2 777 7099
Email: mail@copperbenelux.org
Web: www.copperbenelux.org

Contact: Mr B Dôme

Copper Development Association

Verulam Industrial Estate
224 London Road
St Albans AL1 1AQ
United Kingdom

Tel: 00 44 1727 731205
Fax: 00 44 1727 731216
Email: copperdev@compuserve.com
Webs: www.cda.org.uk & www.brass.org

Contact: Mrs A Vessey

Deutsches Kupferinstitut e.V

Am Bonnheshof 5
D-40474 Duesseldorf
Germany

Tel: 00 49 211 4796 323
Fax: 00 49 211 4796 310
Email: sfassbinder@kupferinstitut.de
Web: www.kupferinstitut.de

Contact: Mr S Fassbinder

ECD Services

Via Cardinal Maffi 21
I-27100 Pavia
Italy

Tel: 00 39 0382 538934
Fax: 00 39 0382 308028
Email: info@ecd.it
Web: www.ecd.it

Contact: Dr A Baggini

European Copper Institute

168 Avenue de Tervueren
B-1150 Brussels
Belgium

Tel: 00 32 2 777 70 70
Fax: 00 32 2 777 70 79
Email: eci@eurocopper.org
Web: www.eurocopper.org

Contact: Mr H De Keulenaer

Hevrox

Schoebroekstraat 62
B-3583 Beringen
Belgium

Tel: 00 32 11 454 420
Fax: 00 32 11 454 423
Email: info@hevrox.be

Contact: Mr I Hendrikx

HTW

Goebenstrasse 40
D-66117 Saarbruecken
Germany

Tel: 00 49 681 5867 279
Fax: 00 49 681 5867 302
Email: wlang@htw-saarland.de

Contact: Prof Dr W Langguth

Istituto Italiano del Rame

Via Corradino d'Ascanio 4
I-20142 Milano
Italy

Tel: 00 39 02 89301330
Fax: 00 39 02 89301513
Email: ist-rame@wirednet.it
Web: www.iir.it

Contact: Mr V Loconsolo

KU Leuven

Kasteelpark Arenberg 10
B-3001 Leuven-Heverlee
Belgium

Tel: 00 32 16 32 10 20
Fax: 00 32 16 32 19 85
Email: ronnie.belmans@esat.kuleuven.ac.be

Contact: Prof Dr R Belmans

Polish Copper Promotion Centre SA

Pl.1 Maja 1-2
PL-50-136 Wroclaw
Poland

Tel: 00 48 71 78 12 502
Fax: 00 48 71 78 12 504
Email: copperpl@wroclaw.top.pl

Contact: Mr P Jurasz

TU Bergamo

Viale G Marconi 5
I-24044 Dalmine (BG)
Italy

Tel: 00 39 035 27 73 07
Fax: 00 39 035 56 27 79
Email: graziana@unibg.it

Contact: Prof R Colombi

TU Wroclaw

Wybrzeze Wyspianskiego 27
PL-50-370 Wroclaw
Poland

Tel: 00 48 71 32 80 192
Fax: 00 48 71 32 03 596
Email: i8@elektryk.ie.pwr.wroc.pl

Contact: Prof Dr H Markiewicz



David Chapman

 **Copper Development Association**

Copper Development Association
Verulam Industrial Estate
224 London Road
St Albans AL1 1AQ
United Kingdom

Tel: 00 44 1727 731200
Fax: 00 44 1727 731216
Email: copperdev@compuserve.com
Websites: www.cda.org.uk
www.brass.org

 **Copper Development Association**

Copper Development Association
Verulam Industrial Estate
224 London Road
St Albans AL1 1AQ
United Kingdom

Tel: 00 44 1727 731200
Fax: 00 44 1727 731216
Email: copperdev@compuserve.com
Websites: www.cda.org.uk and www.brass.org



European Copper Institute
168 Avenue de Tervueren
B-1150 Brussels
Belgium

Tel: 00 32 2 777 70 70
Fax: 00 32 2 777 70 79
Email: eci@eurocopper.org
Website: www.eurocopper.org